

THE GEDORE TROLLEY



- Load capacity**
 - > The load capacity of the drawers is 40 kg
 - > Models 2004*, 2005, 1502, 1504*, 1504.XL, 1506 XL: The bottom drawer is designed as heavy-duty drawer, load capacity 60 kg
 - > * apart from 2004 1000, 1504 1000

- Ball-bearing drawer slides**
 - > The ball-bearing drawer slides ensure safe and easy sliding of the drawers, even when loaded to full capacity

- Individual drawer locking**
 - > In addition to the central locking, each drawer has its own separate latch to prevent unwanted opening, when being moved
 - > The latch is automatically released by a tilting bar when the drawer is opened
 - > The single latch automatically engages when the drawer closes
 - > When marked with "E" the drawers are delivered with individual drawer blocking

- Central locking**
 - > One central lock for all drawers and doors
 - > Safe and easy handling



- Square perforation 10 x 38 mm**
 - > The square perforation in the side walls enable quick access to frequently used tools
 - > GEDORE holders and trays are simply clipped in

- Smooth running wheel**
 - > Precision ball bearing

- Powder coating**
 - > This coating method guarantees a high level of corrosion protection, combined with tough scratch resistance
 - > Special colours available on request

- Heel protection**
 - > All-round heel protection by rounded edges on the underside allows the tool trolley or workbench to be safely pulled or pushed

- High-performance wheel**
 - > High load capacity
 - > Tyres made from solid rubber
 - > Roller bearing
 - > Resistant to abrasion

- Impact protection**
 - > The vertical impact protection protects the tool trolley and anything it comes into contact with from damage
 - > It also protects other equipment in the workshop or vehicles from inadvertent contact

- Total brake**
 - > Prevents unwanted movement and turning of the wheel
 - > Ensures safe parking of the tool trolley or workbench



Tool Trolleys

2005 TOOL TROLLEY

Body:

- > Dimensions: H 985 x W 775 x D 475 mm
- > Working platform in ABS, with 3 compartments for small parts
- > With handle for easy pushing, pulling and turning
- > Side walls with Euro perforation 10 x 38 mm to fix hooks and tools
- > Heel and impact protection for your safety
- > Sheet steel, corrosion resistant and scratch-proof powder-coated, GEDORE blue

Drawers:

- > Central locking with cylinder lock
- > Wide drawers (W 640 x D 400 mm) fully extendable, removable
- > Each drawer with safety locking, single-hand operation
- > Ball-bearing guide rails
- > Can be individually equipped with lengthwise and crosswise dividers (can be ordered individually)
- > Load capacity per drawer 40 kg, bottom heavy-duty drawer 60 kg
- > Sheet steel, corrosion resistant and scratch-proof powder-coated, GEDORE blue

GEDORE High-performance chassis:

- > Total load capacity 500 kg
- > 2 high-performance wheels on roller bearings (fixed castors Ø 200 mm)
- > 2 smooth running wheels on ball bearings (swivel castors Ø 125 mm), both with total brake
- > The GEDORE axle construction secures smooth running, manoeuvrability and track-keeping also in case of maximum loads

Accessories:

- > Length- (LD) and crosswise (CD) dividers from zinc-plated sheet steel

Options:

- > Can be equipped with GEDORE tool modules (1500 ES/1500 CT or 2005 CT)
- > Optionally extendable with GEDORE tool chests, rear panels and tool holders
- > Further drawer combinations on request
- > Special colours and designs available on request
- > Delivery without tools and accessories



2005 0511

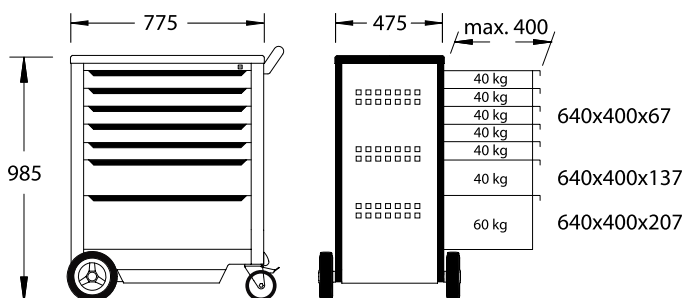



2005 VARIANTS



No.	2005 0511	2005 0511 E	2005 0321
	7 drawers: 5x type 1, H = 67 mm 1x type 2, H = 137 mm 1x type 3, H = 207 mm	7 drawers: 5x type 1, H = 67 mm 1x type 2, H = 137 mm 1x type 3, H = 207 mm	6 drawers: 3x type 1, H = 67 mm 2x type 2, H = 137 mm 1x type 3, H = 207 mm
H	985	985	985
W	775	775	775
D	475	475	475
LD	10x	10x	6x
CD	2x	2x	2x
	93.0	93.0	89.0
Code	1803018	2827379	2003546



No.	2005 0701	2005 0810
	8 drawers: 7x type 1, H = 67 mm 1x type 3, H = 207 mm	9 drawers: 8x type 1, H = 67 mm 1x type 2, H = 137 mm
H	985	985
W	775	775
D	475	475
LD	10x	15x
CD	2x	3x
	92.0	99.0
Code	2003554	2003562

2430

›24



R 2004 L

›25



RT 2004 L

›25

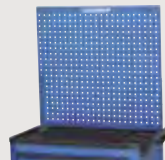
SL 2013 / SL 3014 / SL 1912 /
SL 1916 ›175/191/218

2004 TOOL TROLLEY

Body:

- > Dimensions: H 985 x W 775 x D 475 mm
- > Working platform in ABS, with 3 compartments for small parts
- > Storage compartment with perforated sheet (Euro perforation 10 x 38 mm), two removable drawers for small parts and door on the handle side
- > With handle for easy pushing, pulling and turning
- > Front side with Euro perforation 10 x 38 mm to fix hooks and tools
- > Heel and impact protection for your safety
- > Sheet steel, corrosion resistant and scratch-proof powder-coated, GEDORE blue

Drawers:

- > Central locking with cylinder lock
- > Wide drawers (W 480 x D 400 mm) fully extendable, removable
- > Each drawer and storage compartment with safety locking, single-hand operation
- > Ball-bearing guide rails
- > Can be individually equipped with lengthwise and crosswise dividers (can be ordered individually)
- > Load capacity per drawer 40 kg, bottom heavy-duty drawer 60 kg (apart from 2004 1000)
- > Sheet steel, corrosion resistant and scratch-proof powder-coated, GEDORE blue

GEDORE High-performance chassis:

- > Total load capacity 500 kg
- > 2 high-performance wheels on roller bearings (fixed castors Ø 200 mm)
- > 2 smooth running wheels on ball bearings (swivel castors Ø 100 mm), both with total brake
- > The GEDORE axle construction secures smooth running, manoeuvrability and track-keeping also in case of maximum loads

Accessories:

- > Length- (LD) and crosswise (CD) dividers from zinc-plated sheet steel

Options:

- > Can be equipped with GEDORE tool modules (1500 ES/1500 CT)
- > Optionally extendable with GEDORE tool chests, rear panels and tool holders
- > Further drawer combinations on request
- > Special colours and designs available on request
- > Delivery without tools and accessories



2004 0131

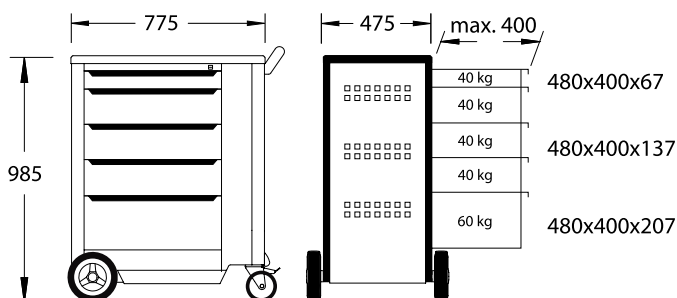

2004 0321

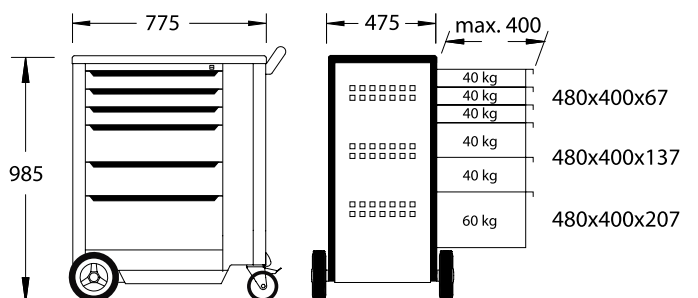



2004 VARIANTS



No.	2004 0131	2004 0321	2004 0511	2004 0511 E
	5 drawers: 1x type 1, H = 67 mm 3x type 2, H = 137 mm 1x type 3, H = 207 mm	6 drawers: 3x type 1, H = 67 mm 2x type 2, H = 137 mm 1x type 3, H = 207 mm	7 drawers: 5x type 1, H = 67 mm 1x type 2, H = 137 mm 1x type 3, H = 207 mm	7 drawers: 5x type 1, H = 67 mm 1x type 2, H = 137 mm 1x type 3, H = 207 mm
H	985	985	985	985
W	775	775	775	775
D	475	475	475	475
LD	3x	6x	10x	10x
CD	2x	2x	2x	2x
	75.0	82.0	84.0	84.0
Code	1640763	1640755	1640739	2827360



No.	2004 0701	2004 0620	2004 0810	2004 1000
	8 drawers: 7x type 1, H = 67 mm 1x type 3, H = 207 mm	8 drawers: 6x type 1, H = 67 mm 2x type 2, H = 137 mm	9 drawers: 8x type 1, H = 67 mm 1x type 2, H = 137 mm	10 drawers: 10x type 1, H = 67 mm
H	985	985	985	985
W	775	775	775	775
D	475	475	475	475
LD	10x	10x	15x	15x
CD	2x	2x	3x	3x
	86.0	88.0	91.0	94.0
Code	1640712	1640720	1640704	1640690

2004 0511

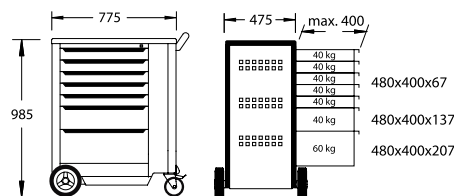

2004 0620

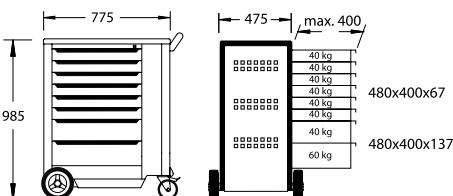

2004 0701

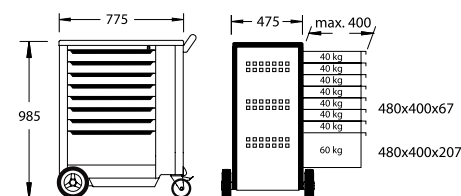

2004 0810

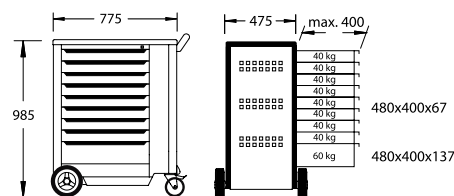

2004 1000

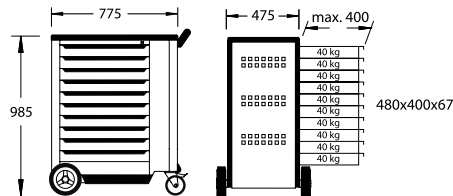

WSL-L7

TOOL TROLLEY WORKSTER SMARTLINE

with 7 drawers

Body:

- > Dimensions: H 1045 x W 785 x D 510 mm
- > Working platform with PP top with front flattening, anti-roll safety edge and small additional trays
- > With handle for easy pushing, pulling and turning
- > Side walls with Euro perforation 10 x 38 mm to fix hooks and tools
- > Sides rounded off – a minimum of abutting edges
- > Welded sheet steel construction, torsionally rigid, to take high loadings
- > Sheet steel, corrosion resistant and scratch-proof powder-coated

Drawers:

- > **Individual blocking** only one drawer can be open at a time, single-hand operation
- > Central locking with cylinder lock
- > 7 wide drawers (W 640 x D 400 mm) fully extendable
- > Ball-bearing guide rails
- > Load capacity per drawer 20 kg
- > Sheet steel, corrosion resistant and scratch-proof powder-coated

GEDORE Chassis

- > Total load capacity 400 kg
- > 4 smooth running wheels on ball bearings (swivel castors Ø 125 mm), one with total brake
- > Even with maximum loads: still smooth running, manoeuvrable and keeps to the track

Options:

- > Can be equipped with GEDORE tool modules (1500 ES, 1500 CT, 2005 CT, TS-147, TS-190, TS-308)
- > Can be individually equipped with lengthwise and crosswise dividers
- > Special colours and designs available on request
- > Delivery without tools and accessories



	H	W	D		Code	No.
7 drawers:	1045	785	510	81.0	2977311	WSL-L7
5x type 1, H = 80 mm						
2x type 2, H = 162.5 mm						



2525-520 TOOL TROLLEY

with 7 drawers

Body:

- > Dimensions: H 965 x W 720 x D 395 mm
- > Working platform in ABS, with 3 compartments for small parts
- > Storage compartment with perforated sheet (square perforation 10 x 38 mm) on the handle side
- > With handle for easy pushing, pulling and turning
- > 1 side wall with Euro perforation 10 x 38 mm to fix hooks and tools
- > All-round heel and impact protection for your safety
- > Sheet steel, corrosion resistant and scratch-proof powder-coated, GEDORE blue

Drawers:

- > Central locking with cylinder lock
- > 5 wide drawers (W 480 x D 325 x H 75 mm) fully extendable
- > 2 large capacity drawers (W 480 x D 325 x H 120 mm) fully extendable, for bulky parts
- > Individual drawer locking, single-hand operation
- > Ball-bearing guide rails
- > Can be individually equipped with lengthwise and crosswise dividers (can be ordered individually, not for the large capacity drawers)
- > Load capacity per drawer 40 kg
- > Sheet steel, corrosion resistant and scratch-proof powder-coated, GEDORE blue

GEDORE High-performance chassis:

- > Total load capacity 330 kg
- > 2 high-performance wheels on roller bearings (fixed castors Ø 140 mm)
- > 2 smooth running wheels on ball bearings (swivel castors Ø 100 mm), one with total brake
- > The GEDORE trapezoidal axle construction secures smooth running, manoeuvrability and track-keeping also in case of maximum loads

Accessories:

- > 10-piece hook assortment
- > 8 length- (LD) and 2 crosswise (CD) dividers from zinc-plated sheet steel

Options:

- > Can be equipped with GEDORE tool modules (1500 ES/1500 CT)
- > Special colours and designs available on request
- > Delivery without tools and accessories

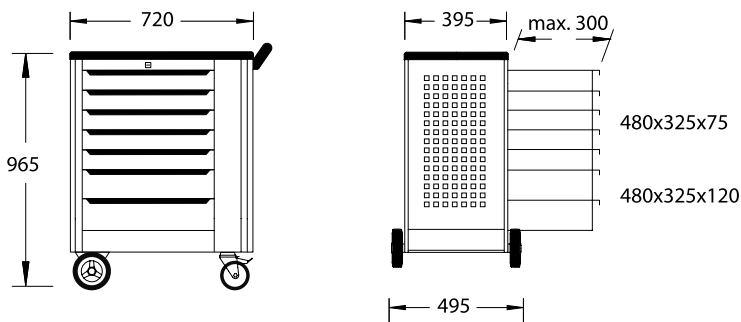

H	W	D	LD	CD		Code	No.
965	720	395	8x	2x	67.0	1587102	2525-520

1580 TOOL TROLLEY

with 4 drawers

Body:

- > Dimensions: H 930 x W 625 x D 400 mm
- > Double sided metal shutters to secure the whole internal space
- > Working platform with ABS top
- > With handle for easy pushing, pulling and turning
- > Side walls with Euro perforation 10 x 38 mm to fix hooks and tools
- > All-round heel and impact protection for your safety
- > Sheet steel, corrosion resistant and scratch-proof powder-coated, GEDORE blue

Drawers:

- > Central locking with cylinder lock
- > 4 wide drawers (W 480 x D 325 x H 45 mm), all drawers open either side
- > 1 deep storage at base
- > Ball-bearing guide rails, with middle and end catches
- > Can be individually equipped with lengthwise and crosswise dividers (can be ordered individually)
- > Load capacity per drawer 20 kg
- > Sheet steel, corrosion resistant and scratch-proof powder-coated, GEDORE blue

GEDORE Chassis

- > Total load capacity 300 kg
- > 2 high-performance wheels on roller bearings (fixed castors Ø 140 mm)
- > 2 smooth running wheels on ball bearings (swivel castors Ø 100 mm), one with total brake
- > The GEDORE trapezoidal axle construction secures smooth running, manoeuvrability and track-keeping also in case of maximum loads

Accessories:

- > 8 length- (LD) and 2 crosswise (CD) dividers from zinc-plated sheet steel

Options:

- > Can be equipped with GEDORE tool modules (1500 ES/1500 CT)
- > Optionally extendable with GEDORE tool chest 1430
- > Special colours and designs available on request
- > Delivery without tools and accessories

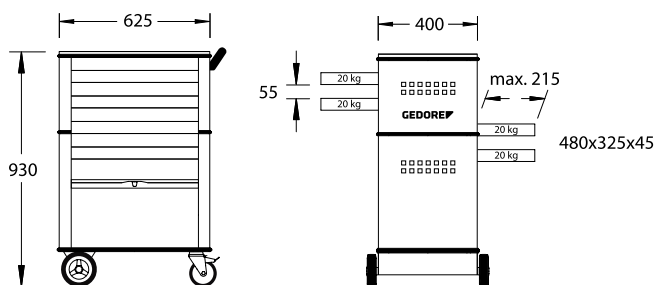

H	W	D	LD	CD		Code	No.
930	625	400	8x	2x	40.0	6627550	1580



1578 TOOL TROLLEY

with 6 drawers

Body:

- > Dimensions: H 930 x W 605 x D 375 mm
- > Working platform in ABS, with 3 compartments for small parts
- > With handle for easy pushing, pulling and turning
- > Heel protection for your safety
- > Sheet steel, corrosion resistant and scratch-proof powder-coated, GEDORE blue

Drawers:

- > Central locking with cylinder lock
- > 4 wide drawers (W 480 x D 325 x H 75 mm)
- > 1 wide drawer (W 480 x D 325 x H 120 mm)
- > 1 wide drawer (W 480 x D 325 x H 210 mm)
- > All drawers open either side
- > Can be individually equipped with lengthwise and crosswise dividers (can be ordered individually)
- > Load capacity per drawer 20 kg
- > Sheet steel, corrosion resistant and scratch-proof powder-coated, GEDORE blue

GEDORE Chassis

- > Total load capacity 200 kg
- > 2 high-performance wheels on roller bearings (fixed castors Ø 140 mm)
- > 2 smooth running wheels on ball bearings (swivel castors Ø 100 mm), one with total brake
- > The GEDORE trapezoidal axle construction secures smooth running, manoeuvrability and track-keeping also in case of maximum loads

Accessories:

- > 6 length- (LD) and 2 crosswise (CD) dividers from zinc-plated sheet steel

Options:

- > Can be equipped with GEDORE tool modules (1500 ES/1500 CT)
- > Special colours and designs available on request
- > Delivery without tools and accessories

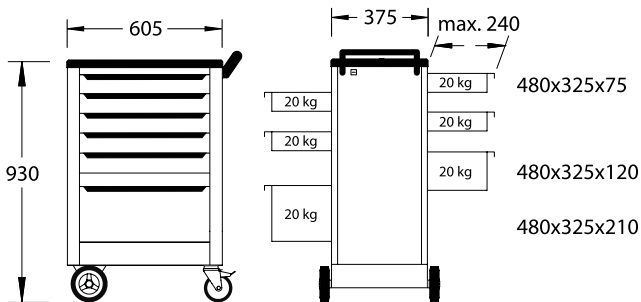

H	W	D	LD	CD		Code	No.
930	605	375	6x	2x	43.5	9018140	1578

Top Tool Chests

Suitable for all GEDORE tool trolleys with a work surface of W 625 x D 400 mm
 Drawers fully extendable
 Supplied with length- and crosswise dividers
 Delivery without tools

1430 TOOL CHEST

> Designed particularly as top box for trolley 1580

Body:

- > Dimensions: H 305 x W 625 x D 400 mm
- > ABS top
- > Heel and impact protection for your safety
- > Sheet steel, corrosion resistant and scratch-proof powder-coated, GEDORE blue

Drawers:

- > Central locking with cylinder lock
- > 3 wide drawers (W 480 x D 325 mm) fully extendable, removable
- > Each drawer with safety locking, single-hand operation
- > Ball-bearing guide rails
- > Can be individually equipped with lengthwise and crosswise dividers (can be ordered individually)
- > Load capacity per drawer 40 kg
- > Sheet steel, corrosion resistant and scratch-proof powder-coated, GEDORE blue

Accessories:

- > 6 length- (LD) and 2 crosswise dividers (CD) in zinc-plated sheet steel

Options:

- > Can be equipped with GEDORE tool modules (1500 ES/1500 CT)
- > Special colours and designs available on request
- > Delivery without tools and accessories

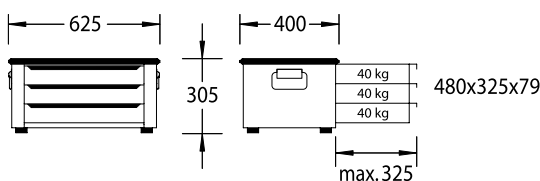

H	W	D	LD	CD		Code	No.
305	625	400	6x	2x	26.0	6618130	1430

2430 TOOL CHEST

Body:

- > Dimensions: H 345 x W 775 x D 475 mm
- > Working platform in ABS with 3 compartments for small parts
- > Sheet steel, corrosion resistant and scratch-proof powder-coated, GEDORE blue

Drawers:

- > Central locking with cylinder lock
- > Wide drawers (W 640 x D 400 x H 67 mm) fully extendable, removable
- > Each drawer with safety locking, single-hand operation
- > Ball-bearing guide rails
- > Can be individually equipped with lengthwise and crosswise dividers (can be ordered individually)
- > Load capacity per drawer 40 kg
- > Sheet steel, corrosion- and scratch-resistant powder-coated, GEDORE blue

Use:

- > Designed particularly as top box for trolleys 2004, 2005

Accessories:

- > 6 length- (LD) and 2 crosswise dividers (CD) in zinc-plated sheet steel

Options:

- > Can be equipped with GEDORE tool modules (1500 ES/1500 CT)
- > Safe locking drawers on request

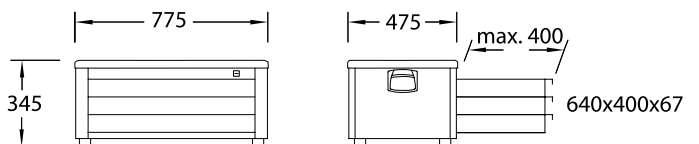
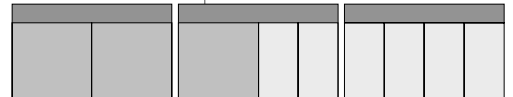

H	W	D	LD	CD		Code	No.
345	775	475	6x	2x	34.0	1888927	2430



Accessories Tool Trolleys

2004 HP
WOOD PLATE

- > To fit in the plastic top, 30 mm thick, to get an additional work surface
- > Multiplex beech wood
- > For tool trolleys 2004 and 2005 and tool chest 2430
- > No. 2004 HP until 03/2014 for depth 435 mm, no. 2004 HP-14 as from 04/2014, for depth 475 mm



W	D	mm	Execution		Code	No.
590	410	30	until 03/2014	5.0	1446967	2004 HP
563	409	30	as from 04/2014	5.0	2879883	2004 HP-14

R 2004 L
REAR PANEL

- > Automatically raised by two gas springs
- > Neat arrangement of tools on square perforation 10 x 38 mm
- > The complete loaded rear wall can be simply lowered
- > Central locking with cylinder lock
- > Can be attached to 2004, 2005
- > Delivery without tools

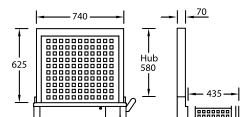

H	W	D		Code	No.
768	770	116	25.0	1446169	R 2004 L

RT 2004 L
REAR PANEL BOARD

- > Square perforation 10 x 38 mm
- > Can be attached to 2004 and 2005 (as well as old models 2002 and 2003)



H	W	D		Code	No.
715	765	30	11.0	2663104	RT 2004 L

1500 H 13
ANTI-SLIP MAT

Products sold by the metre

- > For all drawers in GEDORE tool trolleys and workbenches
- > Various areas of application: Workshop, household, car, spare time...
- > Enormous slip resistance on many different surfaces
- > Can be cut to size
- > Resistant to temperatures from -30 °C to +100 °C
- > Melting point approx. +250 °C
- > Flame resistant
- > Resistant to chemicals
- > Shock- and noise absorbing
- > Dimensions: W 475 x L 2000 mm

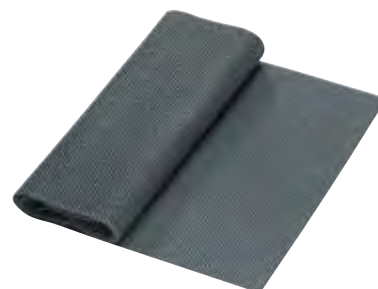

L m	W		Code	No.
2	475	0.540	5790250	1500 H 13