

TSN SLIPPER

Pre-set ratchet head torque wrench with automatic actuation and slip function. Over-tightening is not possible.



Integrated ratchet function
Particularly dependable ratchet having 36 teeth (759-00/-01) or 48 teeth (759-02/-03). Slip-through function guarantees controlled and safe screw tightening, even in hard-to-access locations.

High repeatability
Guarantees constant tightening torques.

Rubber handgrip
Ergonomic and pleasant to hold in your hand. Prevents slipping.

Robust casting part
Made of corrosion-resistant, rustproof material.

Output square drive
Made of quality steel with ball-locking mechanism



Working principle

TSN SLIPPER

When the pre-set torque value is achieved, the mechanism slips through over the ball (without the possibility of over-tightening). The torque wrench is then immediately ready for the next operation.

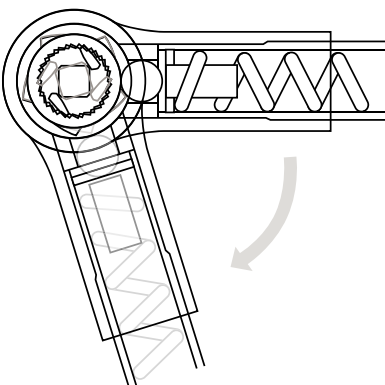

Technical information

TSN SLIPPER & TBN BREAKER

All TSN SLIPPER and TBN BREAKER torque wrenches (apart from 760-00/-01) are fitted with the patented "Mechanical Torque Adjustment Locking Device" to modify torque tester.

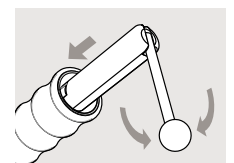
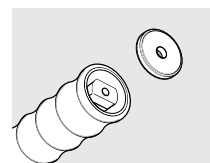
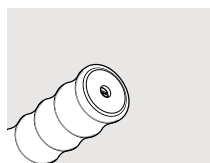

759

TORQUE WRENCH TSN SLIPPER

5-125 N·m / pre-set

Use:

- > Controlled screw tightening in the range 5 - 125 N·m
- > Serial / production-line assembling
- > Extremely long-term work

Features:

- > Pre-set production torque wrench - without scale
- > 1/4", 3/8" or 1/2" square drive with ball locking device
- > With integrated ratchet-function for controlled clockwise tightening
- > Working accuracy: +/- 4 % tolerance of the set torque
- > Acc. to DIN EN ISO 6789, traceable to national standards
- > Precision mechanism slips very noticeably and audibly ("click") when the pre-set value is achieved - over-tightening is not possible
- > Automatic resetting to the starting position
- > Lightweight yet robust and corrosion-resistant construction design

- > Very convenient non-slip rubber handgrip
- > The pre-setting can be made at the factory or by the user on suitable torque testers
- > If ordering, please specify the N·m value - if a factory pre-setting is desired (price on request)
- > EPA-conformant (Electrostatic Protected Area), for use in sensitive electrostatic applications

Scope of delivery:

- > Torque wrench type TSN SLIPPER
- > Special adjusting key for changing the pre-set torque value
- > Test certificate acc. to DIN EN ISO 6789
- > Delivered in sturdy cardboard packaging



- > **TSN SLIPPER** - the pre-set production torque wrench (without scale).
- > With this torque wrench, accidental adjustment while working is ruled out.
- > The state-of-the-art lightweight production wrenches "slip" through as soon as the set torque is achieved.
- > Over-tightening is impossible.
- > The ideal torque tool for all jobs where for a longer time only one tightening torque value is required.
- > The automatic resetting and integrated ratchet are the ideal assistance for working swiftly.

- > TSNs for counter-clockwise tightening, bi-directional tightening without a ratchet-function or as a VDE-Wrench can be manufactured specially - on request.



"	■	N·m	l- mm -l	⚖	Code	No.
1/4	6.3	5-25	216	0.340	7091900	759-00
3/8	10.0	5-25	216	0.340	7092040	759-01
3/8	10.0	15-55	324	0.800	7092120	759-02
1/2	12.5	40-125	460	1.360	7092200	759-03

761 TORQUE WRENCH TSP SLIPPER

1-10 N·m / pre-set

- Use:**
- > Controlled screw tightening in the range 1 - 10 N·m
 - > Ideal for assembly work where controlled tightening with low torque values is required (e.g. electronic hardware sector, precision mechanics etc.)
- Features:**
- > Pre-set production torque wrench - without scale
 - > 1/4" square drive with ball locking device
 - > With integrated ratchet-function for controlled clockwise tightening
 - > Working accuracy: +/- 6 % tolerance of the set torque
 - > Acc. to DIN EN ISO 6789, traceable to national standards
 - > Precision mechanism slips very noticeably and audibly ("click") when the pre-set value is reached - over-tightening is not possible
 - > Automatic resetting to the starting position
 - > 2 models in the range 1 N-m to 10 N-m
- > Extremely lightweight yet robust and corrosion-resistant construction design
- > Very convenient non-slip rubber handgrip
- > EPA-conformant (Electrostatic Protected Area), for use in sensitive electrostatic applications
- > The pre-setting can be made at the factory or by the user on suitable torque testers
- > **If ordering, please specify the N·m value - if a fixed factory pre-setting is desired (price on request)**
- Scope of delivery:**
- > Torque wrench type TSP SLIPPER
 - > Adjusting tool for changing the pre-set torque value
 - > Test certificate acc. to DIN EN ISO 6789
 - > Delivered in sturdy cardboard packaging



- > **TSP SLIPPER** - the pre-set production torque wrench (without scale) for the lower torque range 1 - 10 N·m.
- > Accidental adjustment while working is ruled out.
- > The built-in ratchet with clockwise tightening and the corrosion-resistant lightweight construction design make this torque wrench the optimum working partner for quick and controlled screw tightening.
- > The integrated slipping mechanism reliably prevents over-tightening - the guarantee for high repeatability and controlled tightening values.



"	■	N·m	↳ mm ‹	⚖	Code	No.
1/4	6.3	1-5	185	0.190	1196650	761-05
1/4	6.3	2-10	185	0.190	1196731	761-10

762 TORQUE WRENCH TSC SLIPPER

1-10 N·m

- Use:**
- > Controlled screw tightening in the range 1 - 10 N·m
 - > Ideal for assembly work where controlled tightening with low torque values is required (e.g. electronic hardware sector, precision mechanics etc.)
- Features:**
- > Adjustable torque wrench - with scale
 - > 1/4" square drive with ball locking device
 - > With integrated ratchet-head function for controlled clockwise tightening
 - > Working accuracy: +/- 6 % tolerance of set torque
 - > Acc. to DIN EN ISO 6789, traceable to national standards
 - > Precision mechanism slips very noticeably and audibly ("click") when the set torque is reached - over-tightening is not possible
- > Automatic resetting to the starting position
- > Micrometre scale graduation: 0.05 N·m / 0.1 N·m
- > 2 models in the range 1 N-m to 10 N-m
- > Extremely lightweight yet robust and corrosion-resistant construction design
- > Very convenient non-slip rubber handgrip
- > EPA-conformant (Electrostatic Protected Area), for use in sensitive electrostatic applications
- Scope of delivery:**
- > Torque wrench type TSC SLIPPER
 - > Test certificate acc. to DIN EN ISO 6789
 - > Delivered in sturdy cardboard packaging
- > The scale is situated on the body tube.
- > The setting is made by rotating the unlocked handgrip with the integrated micrometre ring.
- > **TSC SLIPPER** - the adjustable torque wrenches (with scale) for the lower torque range 1 - 10 N·m.
- > The built-in ratchet with clockwise tightening and the corrosion-resistant lightweight construction design make this torque wrench the optimum working partner for quick and controlled screw tightening.
- > The integrated slipping mechanism reliably prevents over-tightening - the guarantee for high repeatability and controlled tightening values.



"	■	N·m	↳ mm ‹	📏	⚖	Code	No.
1/4	6.3	1-5	195	0,05 N·m	0.235	1196480	762-05
1/4	6.3	2-10	195	0,1 N·m	0.235	1196510	762-10

TBN BREAKER

Pre-set torque wrench with automatic snap actuation. Torque wrench offering maximum accuracy. Guaranteed tightening values without over-tightening.

+ **Drive**
16 mm spigot end or 9x12 mm rectangular cavity made of quality steel with pin-locking mechanism

+ **Breaking**
All TBN breaking torque wrenches break by 20° at the pivot point when the set torque is achieved. The models 760-00/-01 can also be set to a breaking angle of 90°.

+ **Patented mechanism**
Guarantees a long product lifespan with guaranteed accuracy values

+ **Rubber handgrip:** Ergonomic and pleasant to hold in your hand. Prevents slipping.

+ **Lightweight steel tube**
Firm, solid, and free of corrosion



TBN Knicker
15
5 - 135 N-m



TBN Knicker
9x12
0,2 - 135 N-m



As an option, we also manufacture the TBN BREAKER models 760-00/-01 with interchangeable fittings directly positioned on the tool.

Working principle

TBN BREAKER

When the TBN breaking torque wrench is operated, the rear section of the driver unit presses the roller. When the pre-set torque value is achieved, the lever switches over and the front section of the drive unit breaks.

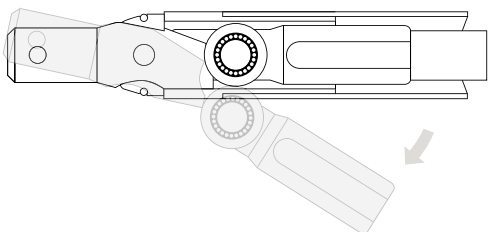

Technical information

TBN BREAKER

TBN BREAKER 760-00/-01 values are changed using the "Double Positive" adjustment system.



760 BREAKING TORQUE WRENCH TBN

0.4-135 N·m / 1.8-1195 lbf·in / pre-set

Use:

- > Controlled screw tightening in the range 0.4 - 135 N·m
- > Serial / production-line assembling
- > Extremely long-term work

Features:

- > Pre-set production torque wrench - without scale
- > With 9x12 mm rectangular-cavity-end or 16 mm spigot-end
- > For bi-directional tightening (the wrench only has to be turned by 180°!)
- > Working accuracy: +/- 4 % tolerance of the set torque
- > Acc. to DIN EN ISO 6789, traceable to national standards
- > Breaking of the handgrip by 20° (90° also possible in the case of no. 760-00/-01) when the pre-set torque value is achieved makes over-tightening unlikely
- > Automatic resetting to the starting position
- > Lightweight yet robust and corrosion-resistant construction design
- > Very convenient non-slip rubber handgrip

- > **No. 760-00/-01: EPA (Electrostatic Protected Area) compliant**
 - > The pre-setting can be made at the factory or by the user on suitable torque testers
 - > **If ordering, please specify the N·m value - if a fixed factory pre-setting is desired (price on request)**
- Scope of delivery:**
- > TBN breaking torque wrench
 - > Adjusting tool for changing the pre-set torque value
 - > Test certificate acc. to DIN EN ISO 6789
 - > Delivered in sturdy cardboard packaging



760-00



760-35



760-50



- > **TBN breaking torque wrench** - the pre-set production torque wrench (without scale).
- > With this torque wrench, accidental adjustment while working is ruled out.
- > The state-of-the-art lightweight production wrenches "break" as soon as the set torque is achieved.
- > Over-tightening is unlikely.
- > The ideal torque tool for all jobs where for a longer time only one tightening torque value is required.
- > For this reason, it is optimally suited for large series.
- > However, the TBN breaking torque wrench is also ideal when varying tightening values are required.

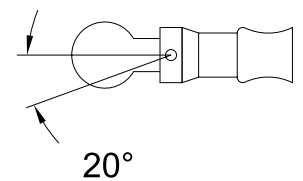

□ mm	∅	N·m	lbf·in	EPA	↳ mm ↲	⚖ kg	Code	No.
9 x 12		0,4-2,0	1,8-18	x	105	0.110	7090690	760-00
9 x 12		2-10	17,8-89	x	105	0.130	7090770	760-01
	16	5-25	44-221		265	0.405	1824686	760-30
9 x 12		5-25	44-221		265	0.405	1824694	760-35
	16	13-65	115-575		302	0.745	1824708	760-40
9 x 12		13-65	115-575		302	0.745	1824716	760-45
	16	27-135	239-1195		408	1.027	1824724	760-50
9 x 12		27-135	239-1195		408	0.830	7092630	760-11

Torque wrench Type 88

8800 TORQUE WRENCH TYPE 88

100-1500 N·m / 70-1000 lbf·ft

Use:

- > Controlled screw tightening in the range 100 - 1500 N-m
- > Industry and vehicle sector (lorries, industrial vehicles), machine maintenance

Features:

- > Adjustable torque wrench - with scale
- > 3/4" square drive with integrated ratchet-function or 22 mm spigot-end
- > Suitable for bi-directional tightening on account of push-through square drive
- > Working accuracy: +/- 4% tolerance of the value setting
- > Acc. to DIN EN ISO 6789, traceable to national standards
- > Breaking mechanism as an actuation signal which can be seen and felt and makes over-tightening unlikely

- > Dual scale in N-m and lbf·ft
- > 5 models in the range 100 - 1500 N-m

Scope of delivery:

- > Type 88 breaking torque wrench
- > Operating instructions are provided on a label on the torque wrench
- > Test certificate acc. to DIN EN ISO 6789
- > Delivered in sturdy cardboard packaging

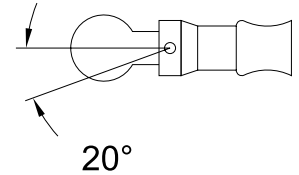

□"	■	∅	N·m	lbf·ft	↳ mm ↲	▬▬▬▬	⚖ kg	Code	No.
3/4	20		100-500	70-350	915	10 N·m	5.5	7715700	8800-01
3/4	20		150-700	100-500	1090	10 N·m	6.0	7715890	8800-02
3/4	20		300-1000	200-750	1470	20 N·m	7.3	7716000	8800-03
3/4	20		700-1500	500-1000	1470	25 N·m	10.5	7716190	8800-04
		22	130-550	100-400	915	10 N·m	4.8	7716270	8800-06